



LES ACROBATES
DE GRAS™
N°325

Visit us at:
www.dcwe.fr

**INSTRUCTION
& USE SHEET**

LA COLLECTION

THE COLLECTION



N°322



N°323

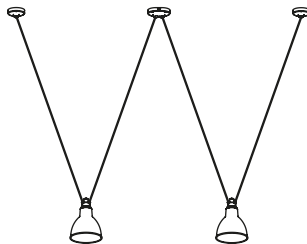

N°324

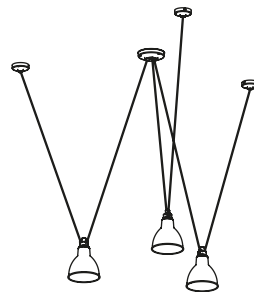

N°325

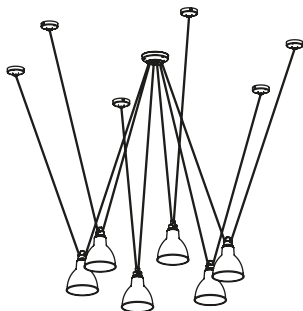

N°326

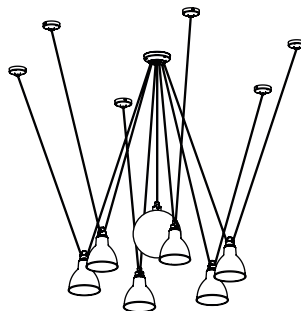

N°327

ATTENTION

- La sûreté de l'appareil n'est garantie qu'en suivant scrupuleusement les instructions. Il est donc nécessaire de les conserver.
- Isoler l'appareil du secteur avant toute manipulation.
- L'appareil ne peut pas être installé dans une autre position que celle indiquée dans les instructions de montage.
- Le montage et les manipulations de l'appareil devront être exécutés avec la plus grande attention pour ne pas abîmer ses composants.
- Tout changement d'ampoule respectera le type et la puissance indiqués dans le descriptif technique.
- Les composants métalliques, en verre ou autre seront entretenus à l'aide d'un chiffon doux et de détergent neutre.
- DCW ÉDITIONS n'échangera ses articles défectueux que par l'intermédiaire d'un revendeur.
- En cas de doute sur le branchement de cette lampe, veuillez consulter un électricien qualifié. Tout câble endommagé doit être remplacé par un professionnel qualifié.

WARNING

- *The safety of this fixture is only guaranteed if the instructions have been observed.*
- *Always disconnect power before working on fixture.*
- *Fixture must not be installed in any position other than that shown in instructions.*
- *Assembly and maintenance of fixture must be performed carefully so as not to damage components.*
- *Replacement bulbs must be of same type and wattage as specified in instructions.*
- *Metal surfaces, glass or other parts of fixture may be cleaned with a soft damp cloth and mild detergent.*
- *DCW ÉDITIONS will replace merchandise with manufacturing defects only if it is returned to the retailer from which it was purchased.*
- *If you are unsure about your wiring, please consult a qualified electrician. The damaged cables should be changed by manufacturer or distributor or qualified electrician.*

COMPOSITIONS

COMPOSITIONS



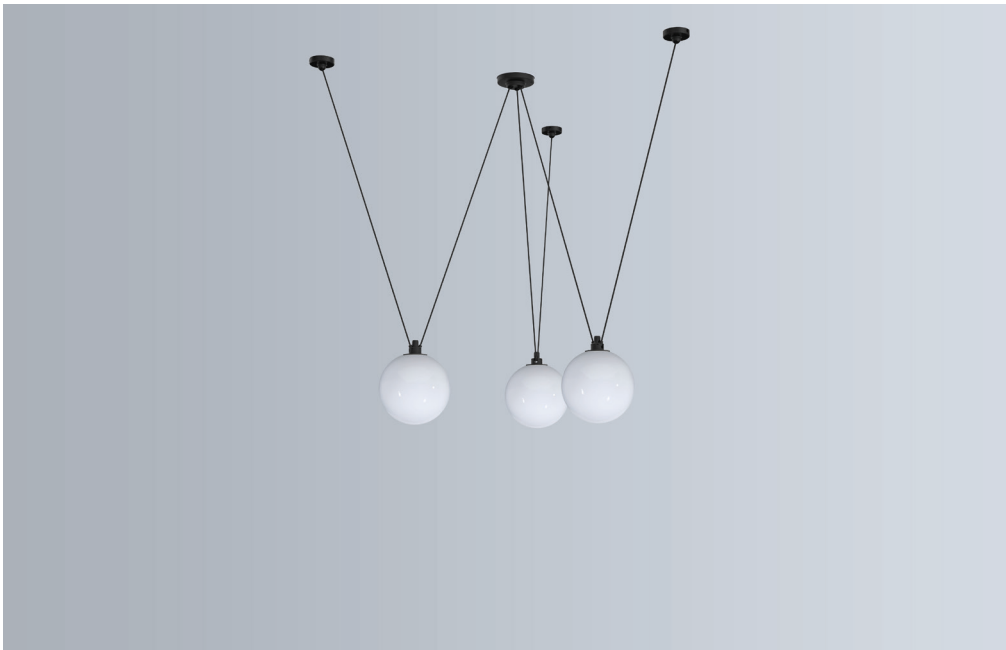



L'ÉLECTRICITÉ

ELECTRICITY



WARNING

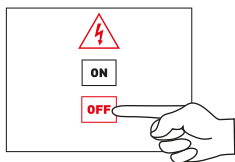

Avant toute manipulation électrique, il est impératif de couper l'alimentation générale car lorsque vous connectez un des câbles, tous les câbles de la lampe sont alors électrifiés

Before any electrical work, it is imperative to shut down the power supply because when you connect one cable, all the cables are live

Fr.

Attention, lorsque vous connectez une des fontes (et quelque soit la fonte **A-B-C** ou **D**), le courant passe dans tous les câbles (**1-2-3-4-5-6**).

Il est donc impératif de laisser la gaine de protection sur les câbles non connectés. Il est interdit de dénuder comme les schémas **X** et **Y**.

EXCEPTION: Les acrobates présentent de nombreux avantages. Entre autres celui de pouvoir « pointer » à l'infini des références Acrobates entre elles.

Dans ce cas, il est préférable de faire appel à un professionnel.

En.

*Be careful, when the lamp is connected (from cast **A-B-C** or **D**), cables **1-2-3-4-5-6** are electrified. It's imperative to keep the protection sleeve on the non-powered cable. It's forbidden to strip the cables like drawings **X** and **Y***

EXCEPTION: *Acrobats have many benefits. For example you can link Acrobats together. In that case it's preferable to ask an electrician*

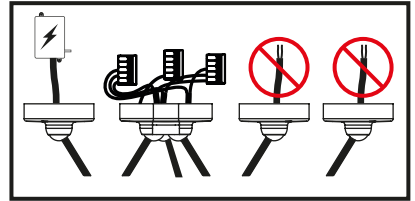
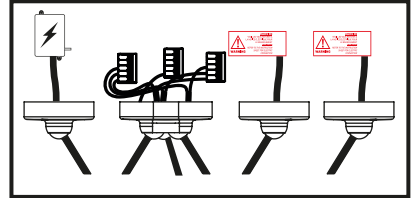
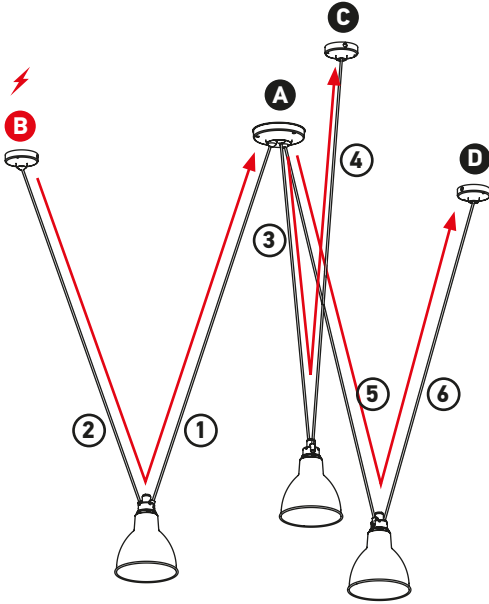

X

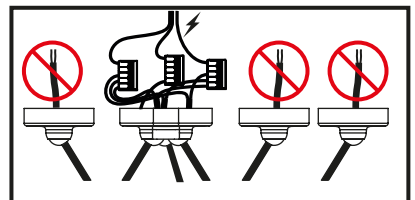
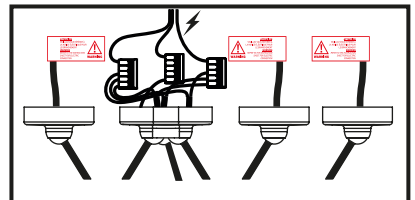
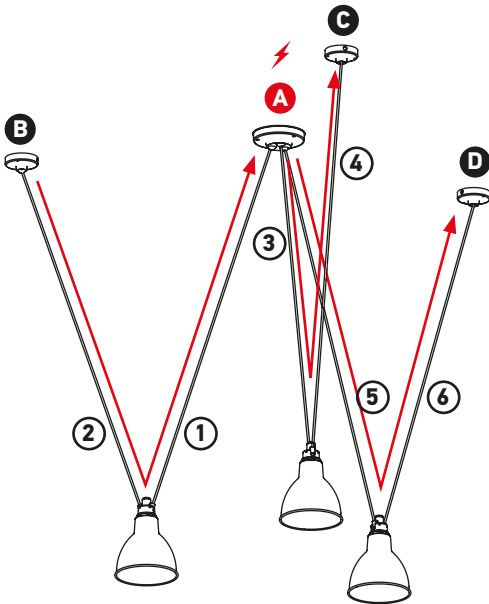

Y

RÉFLECTEURS COMPATIBLES

COMPATIBLE SHADES

LARGE

ROUND

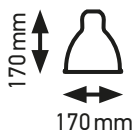

CONIC



COULEURS / COLORS



BLACK



RED



YELLOW



BLUE



BLACK
COPPER



COPPER



COPPER
WHITE



RAW
COPPER



RAW
COPPER
WHITE

XL

ROUND



CONIC

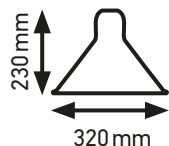

COULEURS / COLORS



BLACK



RED



YELLOW



BLUE



RAW
COPPER



RAW
COPPER
WHITE

OCULISTE



COULEURS / COLORS



BLACK



RED



YELLOW



BLUE



CHROME

GLASS BALL



Ø175 mm



Ø250 mm

INFORMATIONS TECHNIQUES

TECHNICAL INFORMATION

3×E27 – 15W MAX



CL I – IP20 (IP 44 avec le réflecteur
XL OUTDOOR / with the XL OUTDOOR
shade)

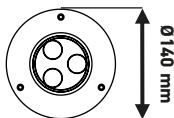

2 pontages possibles /
2 connections possible



STEP 1.

Fr.

Après avoir défini la géométrie de votre lampe (écartement des fontes et longueur des câbles), ajuster la longueur des câbles et verrouiller la position à l'aide de la vis située dans la sphère

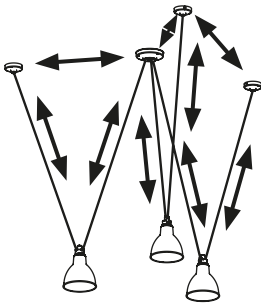

En.

Define the geometry of the lamp (distance between the casts and cables length), then adjust the wires length, then fix it with the plastic screws in the sphere

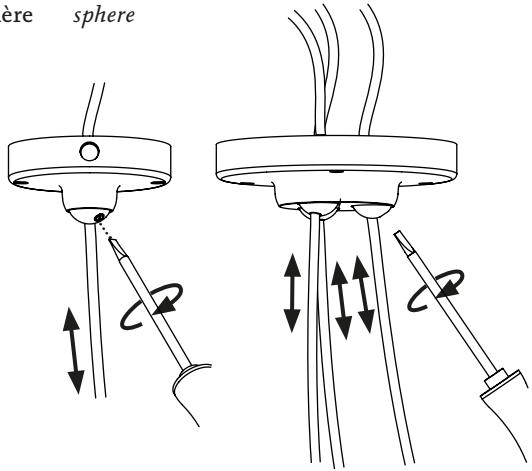

STEP 2.

Fr.

Tracez à l'aide de la fonte et percez avec un foret Ø7

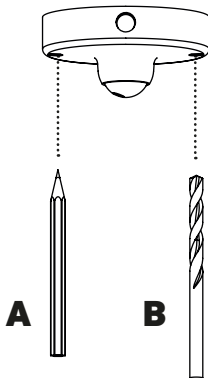

En.

Trace then make holes with drill bit Ø7

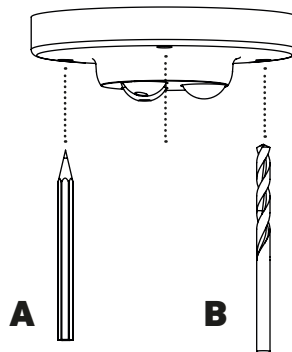

STEP 3.

Fr.

Un des avantages des acrobates est de pouvoir alimenter sa lampe par n'importe quelle fonte **A-B-C** ou **D**.

Si vous décidez d'alimenter votre lampe par la fonte **A**, connectez les câbles **1-3** et **5** aux borniers se trouvant dans la fonte **A**, puis connectez les borniers à l'alimentation électrique.

Si vous avez connecté votre lampe par la fonte **A**, laissez les protections sur les câbles **2-4-6** dans les fontes **B-C-D**!

En.

One of the benefits of the Acrobats range is to be able to connect the lamp through cast **A-B-C** or **D**

If the power comes from cast **A**, connect the cables **1-3** and **5** to connectors in the cast **A** then connect them to power supply.

If connection is made through cast **A**, keep the protection sleeve on the non-powered cable **2-4-6** in the cast **B-C-D**!

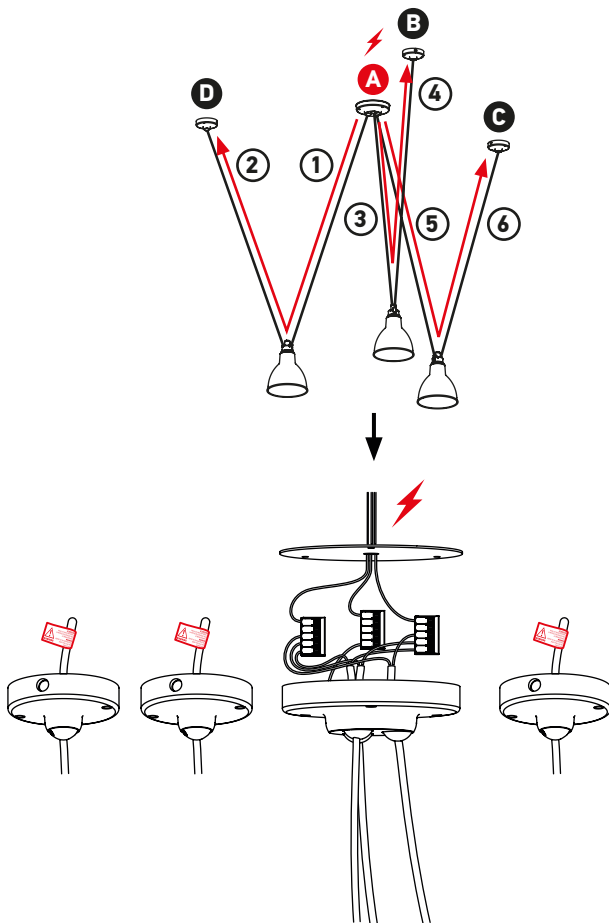

Fr.

Si vous décidez d'alimenter votre lampe par la fonte **B-C** ou **D** connectez les câbles **1-3** et **5** aux borniers se trouvant dans la fonte **A**, puis connectez le boîtier de connexion se trouvant dans la fonte **B-C** ou **D** à l'alimentation électrique.

Laissez la protection sur les câbles non connectés à l'alimentation!

En.

If the power comes from cast **B-C** or **D**, connect the cables **1-3** and **5** to connectors in the cast **A** then connect the terminal box located in cast **B-C** or **D** to power supply.

Keep the protection sleeve on the non-powered cables!

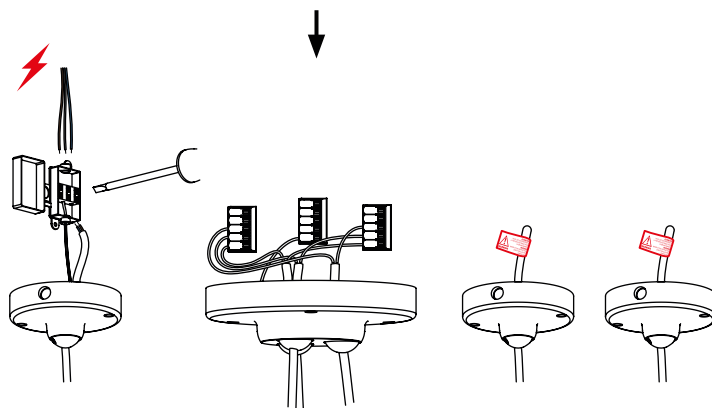
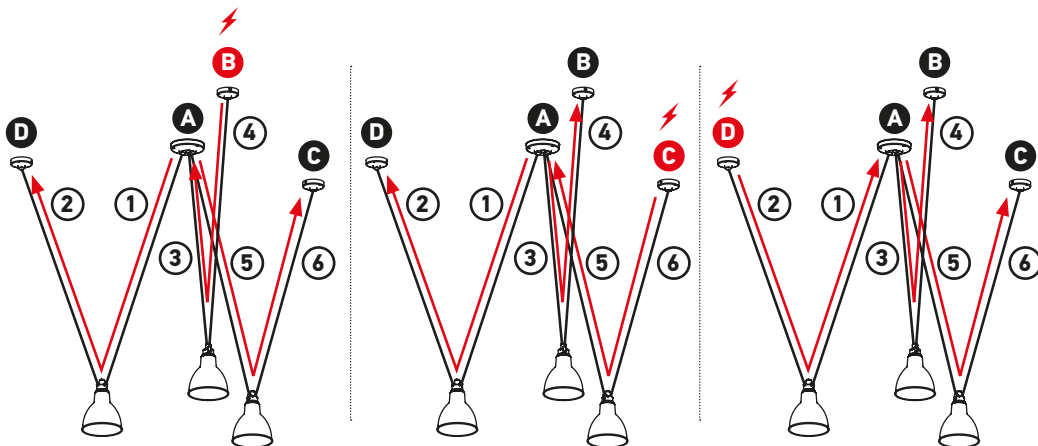

STEP 4.

Fr.

Fixez la/les fonte(s) au plafond

En.

Fix the cast(s) to the ceiling

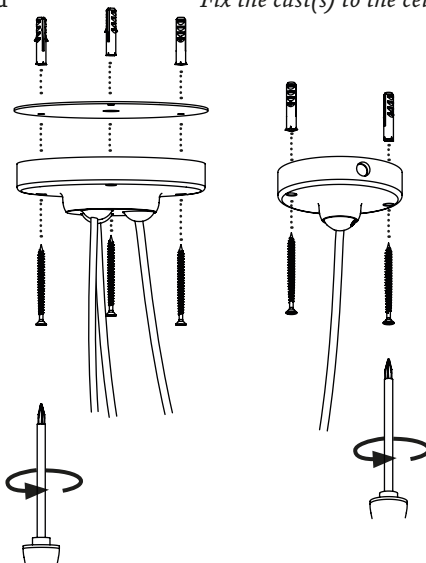

STEP 5.

Fr.

Positionnez l'abat-jour, le manchon et serrez la bague

En.

Place the shade, the sleeve then lock it with the clamping ring

