



MOS

TECHNISCHES BLATT
SCHEDA TECNICA
DATA SHEET
FICHE TECHNIQUE

MOS

DESIGN GAMFRATESI, 2020



MOS ist eine Familie von Möbeln bestehend aus seiner Bank, zwei Lagereinheiten, und Beistelltisch den auch als Nachttisch verwendet werden kann.

Die Hülle aus Wiener Geflecht verbirgt die Regale aus offenporigem, lackiertem Eschefurnier: zwei für die Bank und den Beistelltisch, drei für die Konsole und vier für das Bücherregal.

Die aus gebogenem Buchenholz Struktur ist schwarz lackiert oder Natur gebeizt und wird von Messingsfüßen gestützt.

MOS è una famiglia di arredi composta da una panca, due mobili contenitori ed un tavolino utilizzabile anche come comodino. Ogni elemento è caratterizzato da un guscio in paglia di Vienna che cela i piani in legno di frassino impiallacciato verniciato a poro aperto: due per panca e tavolino, tre per la consolle e quattro per la libreria. La struttura in legno di faggio curvato laccato nero o in naturale è sostenuta dai piedi con puntali in ottone.

MOS is a family of furnishings made up of one bench, two storage units and a side table, which can also be used as a bedside table. The woven cane shell conceals the open pore painted wooden tops in ash veneer: one for the bench and side table, three for the console and four for the bookcase. The frame in natural stained or black lacquered bent beech wood is supported by brass feet.

MOS est une famille de meubles composée de un banc, deux éléments de rangement et une table basse qui peut également être utilisée comme table de chevet.

La coque en paille de Vienne cache les plateaux en bois en plaqué frêne teinté à pores ouverts: deux pour le banc et la table basse, trois pour la console et quatre pour la bibliothèque.

La structure en bois de hêtre courbé laqué noir ou teintée naturel est soutenue par les pieds en laiton.



LBMOSGPG

Dimensions mm.
height 1400 | width 1360 | depth 430



CNMOSGPGC

Dimensions mm.
height 910 | width 1360 | depth 430



TBMOSGLGP

Dimensions mm.
height 450 | width 500 | depth 470



PCMOSGTEP

Dimensions mm.
height 440 | width 1360 | depth 430



PCMOSGTEP + PWMOSGTES

Dimensions mm.
height 440 | width 1360 | depth 430



PCMOSGTEP + PWMOSGTE2

Dimensions mm.
height 440 | width 1360 | depth 430

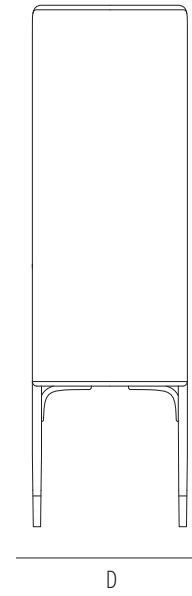
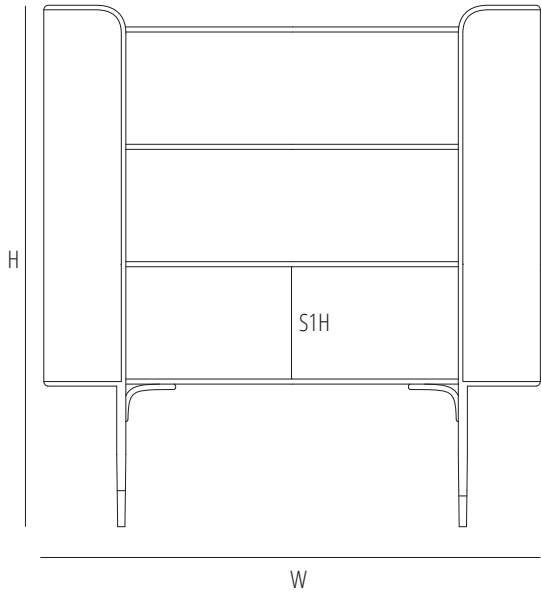

	H	W	D	SH	AH	S1H
mm	1400	1360	430			290
inch	55,1	53,5	16,9			11,4

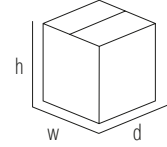
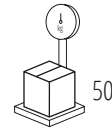
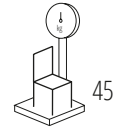

mm - inch
 h 1450 - 57,0
 w 1410 - 55,1
 d 500 - 19,6

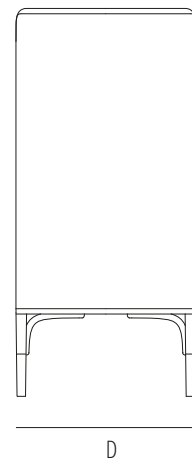
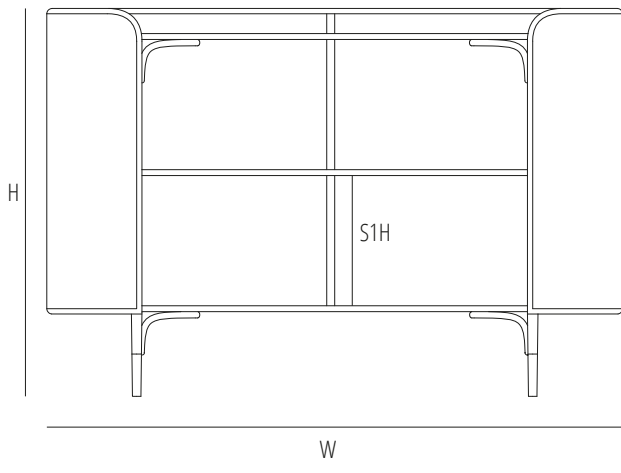

	H	W	D	SH	AH	S1H
mm	910	1360	430			290
inch	35,8	53,5	16,9			11,4

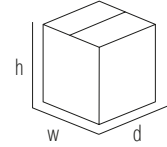
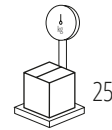

mm - inch
 h 1000 - 39,7
 w 1400 - 55,1
 d 500 - 19,6

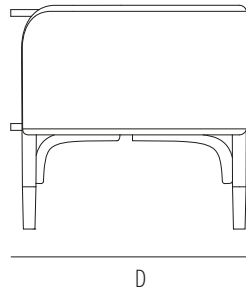
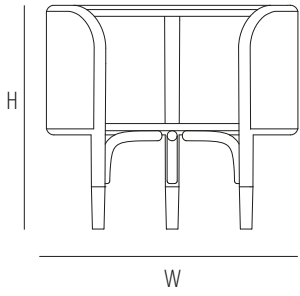

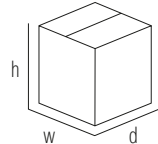
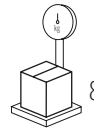
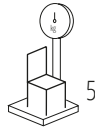

	H	W	D	SH	AH	S1H
mm	450	500	470			
inch	17,7	19,6	18,5			

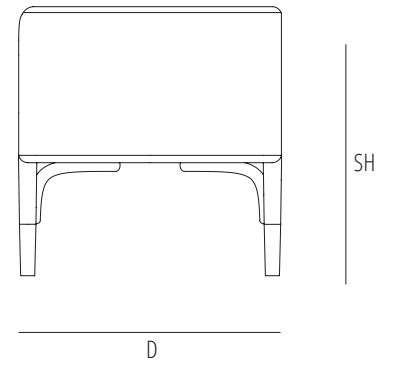
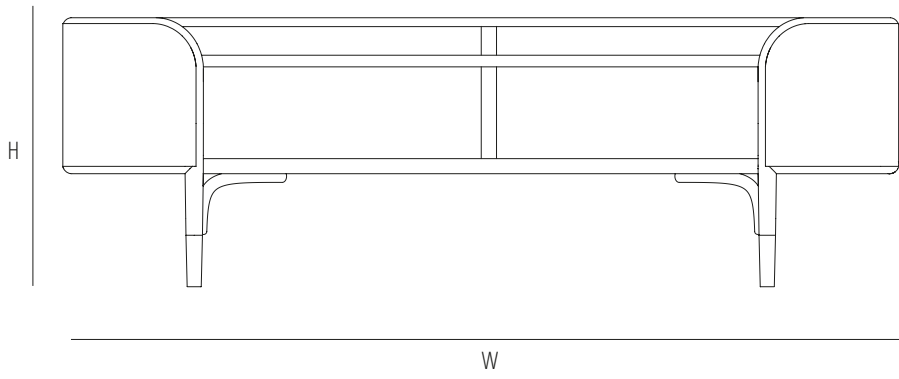

mm - inch
 h 500 - 19,6
 w 550 - 21,6
 d 520 - 20,4





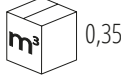
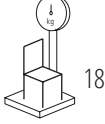
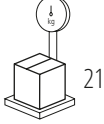
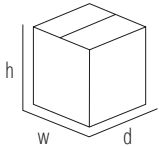

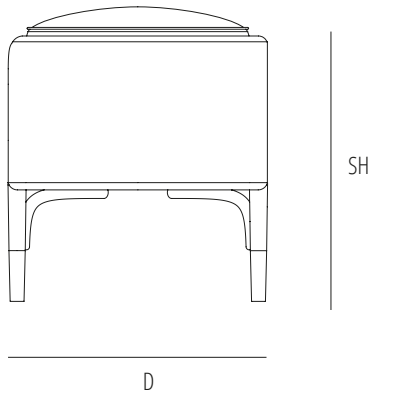
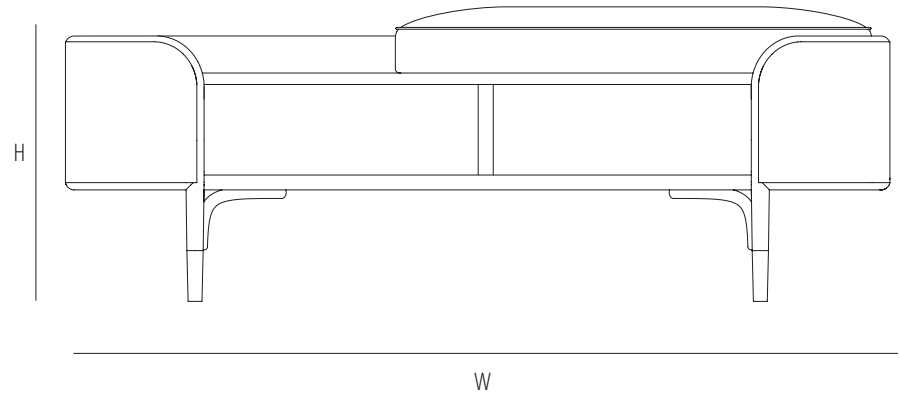
	H	W	D	SH	AH
mm	440	1360	430	370	
inch	17,3	53,5	16,9	14,5	

 1
  max. 1
  0,35
  18
  21
 
 mm - inch
 h 500 - 19,6
 w 1400 - 55,1
 d 500 - 19,6



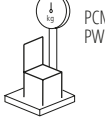
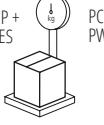
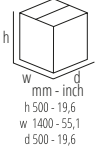
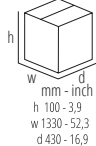

	H	W	D	SH	AH
mm	440	1360	430	370	
inch	17,3	53,5	16,9	14,5	

1 Pz/Pc: 150 cm. Linear x 140 cm h/width

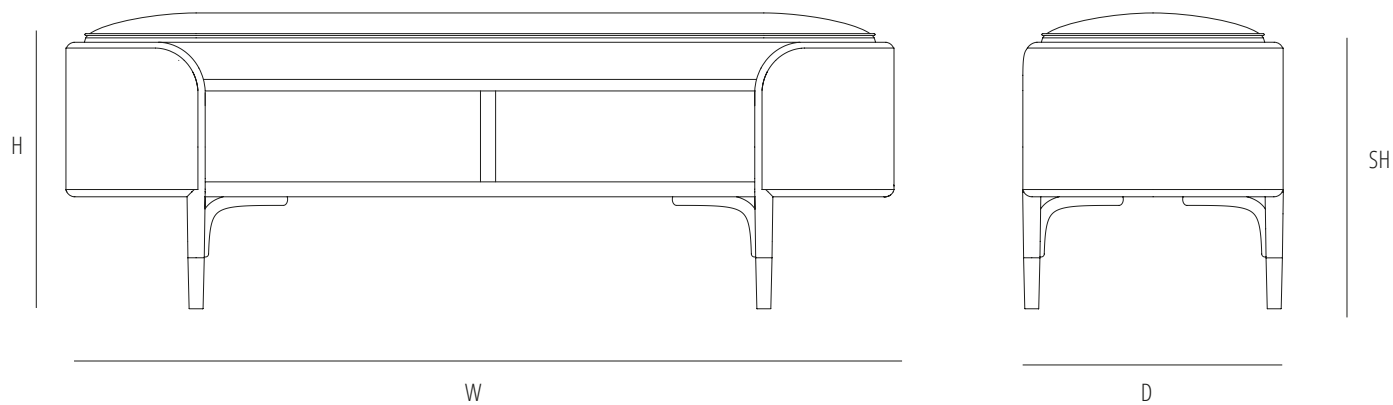
 2
  max. 1
  0,35
  0,05
  21,5
  24,5
 
 PCMOSGTEP
 h 500 - 19,6
 w 1400 - 55,1
 d 500 - 19,6
 
 PWMOSGTEP
 h 100 - 3,9
 w 1330 - 52,3
 d 430 - 16,9

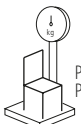
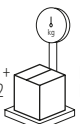
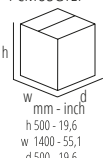
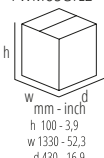

	H	W	D	SH	AH	
mm	440	1360	430	370		1 Pz/Pc: 200 cm. Linear x 140 cm h/width
inch	17,3	53,5	16,9	14,5		

 2	 max. 1	 PCMOSGTEP 0,35 PVMOSGTE2 0,05	 PCMOSGTEP + PVMOSGTE2 25	 PCMOSGTEP + PVMOSGTE2 28	 PCMOSGTEP h w mm - inch d h 500 - 19,6 w 1400 - 55,1 d 500 - 19,6	 PVMOSGTE2 h w mm - inch d h 100 - 3,9 w 1330 - 52,3 d 430 - 16,9
--	---	---	---	--	---	--

Verfuegbare Ausfuehrungen
Finiture disponibili
Available finishes
Finitions disponibles

SOLID WOOD / ESSENZE NATURALI

FRAME



B01 BEECH
B01 FAGGIO

SHELVES



B07 ASH
B07 FRASSINO

CLASSIC LACQUER / LACCATO CLASSICO

FRAME / SHELVES

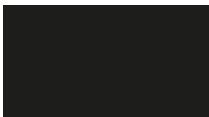

C01 - RAL 9005 BLACK

*Ash wood is open-pore painted
* L'essenza frassino è verniciata a poro aperto

Gebrüder Thonet Vienna GmbH
Prinz Eugen Straße 42
1040 Wien (AT)

www.gebruederthonetvienna.com

Offices of the trademarks' licensee
Production Furniture International S.p.A.
Via Foggia, 23/H
10152 Torino (TO) Italy

Phone: 0039 011 0133330 - info@gebruederthonetvienna.com